

DEWALT®

DEWALT

DC212 DC213

충전 로타리 해머 드릴

DC212/DC213*

EC-적합성 선언

C E

DC212/DC213

상기 DEWALT 사의 전동공구 제품들은 98/37/EEC, 89/336/EEC, 73/23/EEC, 86/188/EEC, EN60745, EN55014-2, EN55014, EN50260, EN60335, EN61000-3-2 와 EN61000-3 의 규격에 따라 설계되었음을 밝힙니다.

기술데이터

		DC212	DC213
전압	V	18	18
무부하속도	min ⁻¹	0-1,100	0-1,100
부하속도	min ⁻¹	-	0-800
타격	J	2.0	2.1
최대드릴범위 철재/목재/콘크리트	mm	10/26/20	10/26/20
툴홀더		SDS-plus®	SDS-plus®
칼라지름	mm	54	54
중량	kg	2.2	2.2
맞대리팩		DE9098	
맞대리형태		NiCd	
전압	VDC	18	
용량	Ah	2.4	
중량	kg	1.	
충전기		D9116	
본선전압	VAC	230	
맞대리형태		NiCd/NiMH	
평균충전시간	분	60/70	
중량	kg	0.4	

기술 및 제품 개발 담당 이사 홀스트 그로스만

다음은 본 설명서에 사용되고 있는 기호입니다 :

본 설명서의 지침을 지키지 않을 경우 나타날 수 있는 신체 부상, 사망 또는 공구 손상의 위험을 나타냅니다.

감전의 위험을 나타냅니다.

화재의 위험을 나타냅니다.

음압 수준 :

		DC212	DC213
LWA (음향 출력)	dB(A)	96	96
KWA (측정 불안정성)	dB(A)	1.9	1.9

가중 평균 제곱근 가속값 :

		DC212	DC213
a _{h,HD}	m/s ²	8.0	8.0
측정 불안정성	m/s ²	1.5	1.5

(서명)

독일, 이드슈타인, D-655510, 리카르드=클링거-슈트라세, DEWALT 사

주요 공지 사항 :

이 사용설명서에 나와 있는 모든 모델들을 한국에서 이용할 수 있는 것은 아닙니다.

DEWALT 의 충전기는 EN60745 의 규격에 따라 이중 절연되어 있습니다.

충전기와 맞대리 팩상의 라벨

이 설명서에서 사용되는 기호들에 더하여, 충전기와 맞대리 팩의 라벨에는 다음과 같은 기호들이 사용됩니다 :

맞대리 충전 중

맞대리 충전 완료

맞대리 결함

전도성 물질을 이용하여 검사하지 마십시오.

손상된 맞대리 팩을 충전하지 마십시오.

사용 전에 설명서를 읽으십시오.

DEWALT®

DC212
DC213

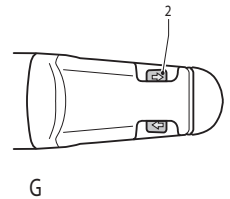
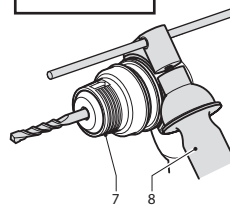
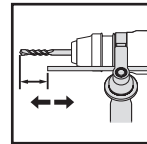
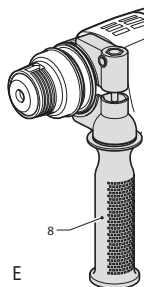
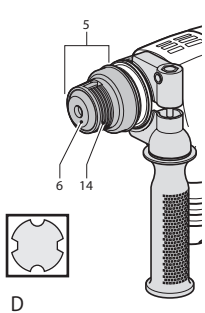
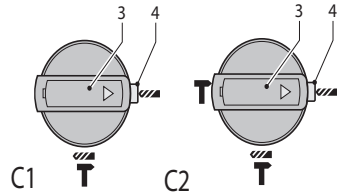
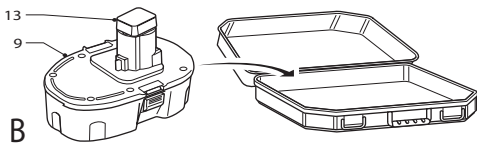
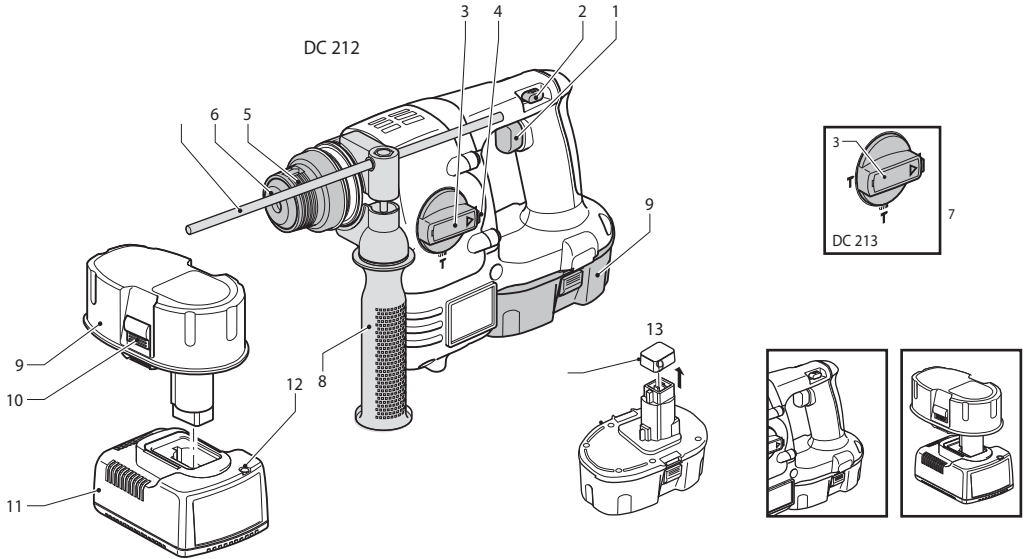

CORDLESS ROTARY HAMMER DRILL DC212/DC213*

EC-Declaration of conformity



DC212/DC213

DEWALT declares that these power tools have been designed in compliance with: 98/37/EEC, 89/336/EEC, 73/23/EEC, 86/188/EEC, EN 60745, EN 55014-2, EN 55014, EN 50260, EN 60335, EN 61000-3-2 & EN 61000-3.

Technical data

	DC212	DC213
Voltage	V 18	18
No-load speed	min ⁻¹ 0 - 1,100	0 - 1,100
Load speed	min ⁻¹ -	0 - 800
Impact energy	J 2.0	2.1
Maximum drilling range in steel/wood/concrete	mm 10/26/20	10/26/20
Tool holder	SDS-plus [®]	SDS-plus [®]
Collar diameter	mm 54	54
Weight (without battery pack)	kg 2.2	2.2

Battery pack	DE9098
Battery type	NiCd
Voltage	V _{DC} 18
Capacity	Ah 2.4
Weight	kg 1.

Charger	DE9116
Mains voltage	V _{AC} 230
Battery type	NiCd/NiMH
Approx. charging time	min 60/70
Weight	kg 0.4

Labels on charger and battery pack

In addition to the pictographs used in this manual, the labels on the charger and the battery pack show the following pictographs:



Battery charging



Battery charged



Battery defective

The following symbols are used throughout this manual:



Denotes risk of personal injury, loss of life or damage to the tool in case of non-observance of the instructions in this manual.



Denotes risk of electric shock.



Fire hazard.

Level of sound pressure:

	DC212	DC213
L _{WA} (acoustic power)	dB(A) 96	96
K _{WA} (measurement uncertainty)	dB(A) 1.9	1.9

Weighted RMS acceleration value:

	DC212	DC213
a _{r,HD}	m/s ² 8.0	8.0
measurement uncertainty	m/s ² 1.5	1.5

Director Engineering and Product Development
Horst Großmann

DEWALT, Richard-Klinger-Straße 11
D-65510, Idstein, Germany

Important Notice:

Not all models shown in this manual are available in Korea



Your DEWALT charger is double insulated in accordance with EN 60745.



Do not probe with conductive objects



Do not charge damaged battery packs



Read instruction manual before use



Use only with DEWALT battery packs, others may burst, causing personal injury and damage

General safety rules

Warning! Read all instructions. Failure to follow all instructions listed below may result in electric shock, fire and/or serious injury. The term „power tool“ in all of the warnings listed below refers to your mains operated (corded) power tool or battery operated (cordless) power tool. SAVE THESE INSTRUCTIONS.

- 1 Work area
 - a Keep work area clean and well lit. Cluttered and dark areas invite accidents.
 - b Do not operate power tools in explosive atmospheres, such as in the presence of flammable liquids, gases or dust. Power tools create sparks which may ignite the dust or fumes.
 - c Keep children and bystanders away while operating a power tool. Distractions can cause you to lose control.
 - 2 Electrical safety
 - a Power tool plugs must match the outlet. Never modify the plug in any way. Do not use any adapter plugs with earthed (grounded) power tools. Unmodified plugs and matching outlets will reduce risk of electric shock.
 - b Avoid body contact with earthed or grounded surfaces such as pipes, radiators, ranges and refrigerators. There is an increased risk of electric shock if your body is earthed or grounded.
 - c Do not expose power tools to rain or wet conditions. Water entering a power tool will increase the risk of electric shock.
 - d Do not abuse the cord. Never use the cord for carrying, pulling or unplugging the power tool. Keep cord away from heat, oil, sharp edges or moving parts. Damaged or entangled cords increase the risk of electric shock.
 - e When operating a power tool outdoors, use an extension cord suitable for outdoor use. Use of a cord suitable for outdoor use reduces the risk of electric shock.
 - 3 Personal safety
 - a Stay alert, watch what you are doing and use common sense when operating a power tool. Do not use a power tool while you are tired or under the influence of drugs, alcohol or medication. A moment of inattention while operating power tools may result in serious personal injury.
 - b Use safety equipment. Always wear eye protection. Safety equipment such as dust mask, non-skid safety shoes, hard hat, or hearing protection used for appropriate conditions will reduce personal injuries.
 - c Avoid accidental starting. Ensure the switch is in the off position before plugging in. Carrying power tools with your finger on the switch or plugging in power tools that have the switch on invites accidents.
 - d Remove any adjusting key or wrench before turning the power tool on. A wrench or a key left attached to a rotating part of the power tool may result in personal injury.
 - e Do not overreach. Keep proper footing and balance at all times. This enables better control of the power tool in unexpected situations.
 - f Dress properly. Do not wear loose clothing or jewellery. Keep your hair, clothing and gloves away from moving parts. Loose clothes, jewellery or long hair can be caught in moving parts.
 - g If devices are provided for the connection of dust extraction and collection facilities, ensure these are connected and properly used. Use of these devices can reduce dust related hazards.
 - 4 Power tool use and care
 - a Do not force the power tool. Use the correct power tool for your application.
 - b Do not use the power tool if the switch does not turn it on and off. Any power tool that cannot be controlled with the switch is dangerous and must be repaired.
 - c Disconnect the plug from the power source before making any adjustments, changing accessories, or storing power tools.
 - d Store idle power tools out of the reach of children and do not allow persons unfamiliar with the power tool or these instructions to operate the power tool. Power tools are dangerous in the hands of untrained users.
 - e Maintain power tools. Check for misalignment or binding of moving parts, breakage of parts and any other condition that may affect the power tools operation. If damaged, have the power tool repaired before use. Many accidents are caused by poorly maintained power tools.
 - f Keep cutting tools sharp and clean. Properly maintained cutting tools with sharp cutting edges are less likely to bind and are easier to control.
 - g Use the power tool, accessories and tool bits etc., in accordance with these instructions and in the manner intended for the particular type of power tool, taking into account the working conditions and the work to be performed. Use of the power tool for operations different from those intended could result in a hazardous situation.
 - 5 Battery tool use and care
 - a Ensure the switch is in the off position before inserting battery pack. Inserting the battery pack into power tools that have the switch on invites accidents.
 - b Recharge only with the charger specified by the manufacturer. A charger that is suitable for one type of battery pack may create a risk of fire when used with another battery pack.
 - c Use power tools only with specifically designated battery packs. Use of any other battery packs may create a risk of injury and fire.
 - d When battery pack is not in use, keep it away from other metal objects like paper clips, coins, keys, nails, screws, or other small metal objects that can make a connection from one terminal to another. Shorting the battery terminals together may cause burns or a fire.
 - e Under abusive conditions, liquid may be ejected from the battery; avoid contact. If contact accidentally occurs, flush with water. If liquid contacts eyes, additionally seek medical help. Liquid ejected from the battery may cause irritation or burns.
 - 6 Service
 - a Have your power tool serviced by a qualified repair person using only identical replacement parts. This will ensure that the safety of the power tool is maintained.
- Additional safety instructions for battery packs and chargers
- Make sure that the battery pack is dry and clean before inserting it into the charger.
 - Use only chargers labelled „NiMH“ or „NiMH + NiCd“ to charge DEWALT NiMH battery packs.
 - Never carry the charger by its cord. Never pull the cord to disconnect from the socket. Keep the cord away from heat, oil and sharp edges.
 - Do not expose the charger to damp or wet conditions.
 - Do not attempt to charge wet battery packs.
 - Never attempt to open a battery pack for any reason.
 - Always follow the instructions in the back of this manual for battery pack disposal.
 - When not in use, chargers and battery packs must be stored in a dry place and locked up securely, out of reach of children.



Do not expose to water



Have defective cords replaced immediately



Charge only between 4 °C and 40 °C



Discard the battery pack with due care for the environment



Do not incinerate the battery pack

Package contents

The package contains:

- 1 Cordless rotary hammer drill
 - 1 Side handle
 - 1 Depth adjustment rod
 - 1 Charger (K-models only)
 - 2 Battery packs (K-models only)
 - 1 Kitbox (K-models only)
 - 1 Instruction manual
 - 1 Exploded drawing
- Check for damage to the tool, parts or accessories which may have occurred during transport.
 - Take the time to thoroughly read and understand this manual prior to operation.

Description (fig. A)

Your cordless rotary hammer drill DC212 has been designed for professional drilling, hammer drilling and screwdriving applications.

Your cordless rotary hammer drill DC213* has been designed for professional drilling, hammer drilling and screwdriving applications as well as for light chipping.

- 1 Variable speed switch
- 2 Forward/reverse slider
- 3 Mode selector
- 4 Safety lock
- 5 Tool holder
- 6 Dust cover
- 7 Depth adjustment rod
- 8 Side handle
- 9 Battery pack

Important Notice:

Not all models shown in this manual are available in Korea

Charger

Your DE9116 charger accepts DEWALT 18 V NiCd and NiMH battery packs.

- 9 Battery pack
- 10 Release buttons
- 11 Charger
- 12 Charging indicator (red)

Overload clutch

In case of jamming of a drill bit, the drive to the drill spindle is interrupted. Because of the resulting forces, always hold the tool with both hands and take a firm stance.

Brake mechanism

When the variable speed switch is released, the spindle will stop rotating instantly.

Active vibration control

The active vibration control neutralises rebound vibration from the hammer mechanism.

Lowering hand and arm vibration, it allows more comfortable use for longer periods of time and extends the life of the unit.

In operation, a spring loaded mechanism counterbalances the vibration forces. This can be sensed by the cushioning effect when pressure is applied to the tool. Make sure the spring is engaged but not too firmly. The mechanism should be allowed to 'float'.

Electrical safety

The electric motor has been designed for one voltage only. Always check that the battery pack voltage corresponds to the voltage on the rating plate. Also make sure that the voltage of your charger corresponds to that of your mains.

Selecting the operating mode (fig. C1 & C2)

DC212 (fig. C1)

The tool can be used in the following operating modes:



Rotary drilling: for screwdriving and for drilling into steel, wood and plastics



Hammer drilling: for concrete and masonry drilling.

DC213* (fig. C2)

The tool can be used in the following operating modes:



Rotary drilling: for screwdriving and for drilling into steel, wood and plastics



Hammer drilling: for concrete and



masonry drilling.
Hammering only: for light chipping.

- To select the operating mode, press the safety lock (4) and rotate the mode selector switch (3) until it points to the symbol of the required mode.
- Release the safety lock and check that the mode selector switch is locked in place.



Do not select the operating mode when the tool is running.

Inserting and removing SDS-plus accessories (fig. D)

Your rotary hammer drill uses SDS-plus accessories (refer to the inset in fig. D for a cross-section of an SDS-plus bit shank).

- Clean and grease the bit shank.
- Insert the bit shank into the tool holder (5).
- Push the bit down and turn it slightly until it fits into the slots.
- Pull on the bit to check if it is properly locked. The hammering function requires the bit to be able to move axially several centimetres when locked in the tool holder.
- To remove a bit pull back the tool holder locking sleeve (14) and pull out the bit.

Fitting the side handle (fig. E)

The side handle (8) can be fitted to suit both RH- and LH-users.



Always use the tool with the side handle properly assembled.

- Loosen the side handle.
- For RH-users, slide the side handle clamp over the collar behind the tool holder, handle at the left.
- For LH-users, slide the side handle clamp over the collar behind the tool holder, handle at the right.
- Rotate the side handle to the desired position and tighten the handle.

Setting the drilling depth (fig. F)

- Insert the required drill bit.
- Slacken the side handle (8).
- Fit the depth adjustment rod (7) through the hole in the side handle clamp.
- Adjust the drilling depth as shown.
- Tighten the side handle.

Forward/reverse slider (fig. G)

- Push the forward/reverse slider (2) to the LH-side for forward (RH) rotation. See arrows on tool.
- Push the forward/reverse slider (2) to the RH-side for reverse (LH) rotation.



Always wait until the motor has come to a complete standstill before changing the direction of rotation.

Replacing the dust cover (fig. D)

The dust cover (6) prevents dust ingress into the mechanism. Replace a worn dust cover immediately.

- Pull back the tool holder locking sleeve (14) and pull the dust cover (6) off.
- Fit the new dust cover.
- Release the tool holder locking sleeve.

Instructions for use



Always observe the safety instructions and applicable regulations.

- Be aware of the location of pipework and wiring.
- Apply only a gentle pressure to the tool (approx. 5 kg). Excessive force does not speed up drilling but decreases tool performance and may shorten tool life.
- Do not drill or drive too deep to prevent damage to the dust cover.
- Always hold the tool firmly with both hands and ensure a secure stance. Always operate the tool with the side handle properly mounted.

Switching on and off (fig. A)

- To run the tool, press the variable speed switch (1). The pressure exerted on the variable speed switch determines the tool speed.
- To stop the tool, release the switch.
- To lock the tool in off position, move the forward/reverse slider (3) to the central position.

Hammer drilling (fig. A)

- Set the mode selector switch (4) to the „hammer drilling“ position.
- Insert the appropriate drill bit. For best results use high quality carbide-tipped bits.
- Adjust the side handle (8) as required.
- If necessary, set the drilling depth.
- Mark the spot where the hole is to be drilled.
- Place the drill bit on the spot and switch on the tool.

Rotary drilling (fig. A)

- Set the mode selector switch (4) to the “rotary drilling” position.
- Fit a chuck adaptor/chuck assembly. Special SDS-plus adaptors with threaded sections are available for use with standard 10 or 13 mm chucks to enable straight shank bits to be used.
- Proceed as described for hammer drilling.



Never use standard chucks in the hammer drilling mode.

Screwdriving (fig. A)

- Set the mode selector switch (4) to the “rotary drilling” position.
- Select the direction of rotation.
- Insert the special SDS-plus[®] screwdriving adaptor for use with hexagonal screwdriver bits .
- Insert the appropriate screwdriver bit. When driving slotted head screws always use bits with a finder sleeve.
- Gently press the variable speed switch (1) to prevent damage to the screw head. In reverse (LH) rotation the tool speed is automatically reduced for easy screw removal.
- When the screw is flush with the workpiece, release the variable speed switch to prevent the screw head from penetrating into the workpiece.

DC213 - Chipping (fig. A)

- Set the mode selector switch (4) to the „hammering only” position.
 - Insert the appropriate chisel and check if it is properly locked.
 - Adjust the side handle (8) as required.
- Switch on the tool and start working.

It may be necessary to briefly run the motor after having changed from chiselling to rotary modes in order to align the gears.



- Do not use this tool to mix or pump easily combustible or explosive fluids (benzine, alcohol, etc.).
- Do not mix or stir inflammable liquids labelled accordingly.

Optional accessories

Various types of SDS-plus[®] drill bits and chisels are available as an option.

Consult your dealer for further information on the appropriate accessories.

Maintenance

Your D EWALT power tool has been designed to operate over a long period of time with a minimum of maintenance. Continuous satisfactory operation depends upon proper tool care and regular cleaning.

- This machine is not user-serviceable. Take the tool to an authorised D EWALT repair agent after approximately 40 hours of use. If problems occur before this time contact an authorised DEWALT repair agent.



Lubrication

Your power tool requires no additional lubrication. Accessories and attachments used must be regularly lubricated around the SDS-plus[®] fitment.



Cleaning

- Unplug the charger before cleaning the housing with a soft cloth.
- Remove the battery pack before cleaning your power tool.
- Keep the ventilation slots clear and regularly clean the housing with a soft cloth.

Protecting the environment



Separate collection. This product must not be disposed of with normal household waste.

Should you find one day that your DEWALT product needs replacement, or if it is of no further use to you, do not dispose of it with household waste. Make this product available for separate collection.



Separate collection of used products and packaging allows materials to be recycled and used again. Re-use of recycled materials helps prevent environmental pollution and reduces the demand for raw materials.

DEWALT provides a facility for the collection and recycling of D EWALT products once they have reached the end of their working life. To take advantage of this service please return your product to any authorised repair agent who will collect them on our behalf.

You can check the location of your nearest authorised repair agent by contacting your local DEWALT office at the address indicated in this manual. Alternatively, a list of authorised DEWALT repair agents and full details of our after-sales service and contacts are available on the Internet at: www.2helpU.com



Rechargeable battery pack

This long life battery pack must be recharged when it fails to produce sufficient power on jobs which were easily done before. At the end of its technical life, discard it with due care for our environment:

- Run the battery pack down completely,

